

Studies in the History of Services and Construction

**The Proceedings of the Fifth Conference of the
Construction History Society**

**Queens' College
Cambridge
6-8 April 2018**

**Edited by
James W P Campbell
Nina Baker
Amy Boyington
Michael Driver
Michael Heaton
Yiting Pan
Henrik Schoenefeldt
Michael Tutton
David Yeomans**

The hidden system: How district heating came to town

Jørgen Burchardt

National Museum of Science and Technology, Denmark

Introduction

District heating, where a building is kept warm by heat produced often a long distance away, has become a very common heating system. In many countries, half of the homes are heated this way. The first plants of this type were seen in the 1800s; in the early 1900s, several major systems were installed; but only in the 1950s did development begin to evolve significantly.

This article will discuss this development phase, as well as the specific installations used for district heating. Local installations in buildings will not be discussed, for the most part, as many installations are similar to central heating. The special facilities associated with the heating of the buildings are few.

Examples are taken from Danish history and based on documentation of the Danish district heating sector carried out at the National Museum of Science and Technology. In many ways, historical development is different from country to country, but the basic technical conditions have become international standards, so this knowledge is also of interest outside Denmark.

The first district heating

The first district heating plant in Denmark was installed in Copenhagen, when the Zoological Museum was built in 1863-69.[1] Its steam heating system was very advanced for the time (Fig. 1). It provided heat not only for the museum, but also for some other buildings in the central part of Copenhagen. This heating system worked well over time, even when the museum's premises were taken over by Copenhagen University. There was no thermostatic control of the radiators, so the fireman had to open and close the steam valves regularly. The author of this article, from his time studying there, can remember how the pipes in the rooms knocked and banged when they expanded or contracted.

The hidden system: How district heating came to town

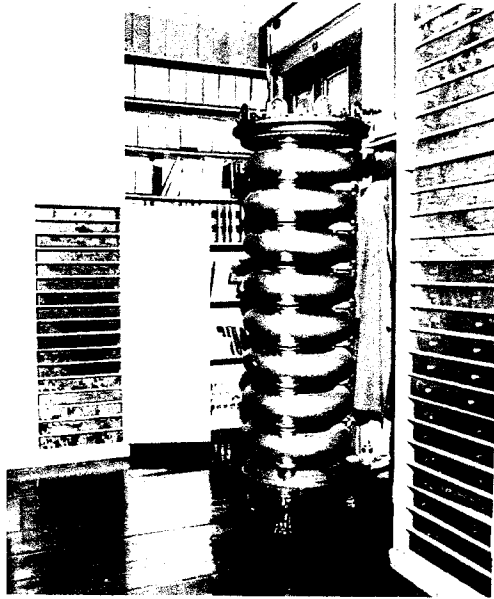

Fig. 1 The steam radiators at the Zoological Museum from 1869 were in service for about 100 years. One of them is today at the National Museum of Science and Technology. The radiators could not be regulated, so the steam passed through the plant several times a day. Photo from 1960.

District heating was soon introduced in other countries. In the United States, in 1877, a system was installed in Lockport, N.Y., and the same designer established facilities in downtown New York, N.Y., in 1882-83.[2]

The next facilities in Denmark were established a few years later. The first was in 1900 at a sanatorium, where the heat of the institution's buildings was generated at a traditional boiler plant with coal fired in an independent economy building.

The next half century's expansion of district heating was not primarily established by a wish for the new energy supply, but as an economical and pragmatic use of surplus heat. After Hamburg, Germany experienced a major epidemic in 1892 due to the spread of contamination from waste, Frederiksberg, a municipality close to Copenhagen, decided to establish a combustion plant (which was built in 1903). The municipality was surrounded by the City of Copenhagen on all sides, and Frederiksberg's city council was worried about exposure to the city's waste. The waste incineration plant was designed, secondarily, to supply heat and electricity to the nearby hospital, to a bathing centre and to schools.

The downstream system similarly made use of waste heat — surplus heat from the big power stations built in the 1920s. This type first turned up in the smaller provincial towns of Brønderslev and Faaborg (Fig. 2), and between 1925 and 1929 it was established in Copenhagen, Esbjerg, Svendborg, Aarhus and Odense, and soon came to the other major cities in the country. Increasing electricity consumption required construction of new power stations and naturally provided an opportunity to spread district heating plants to more customers.

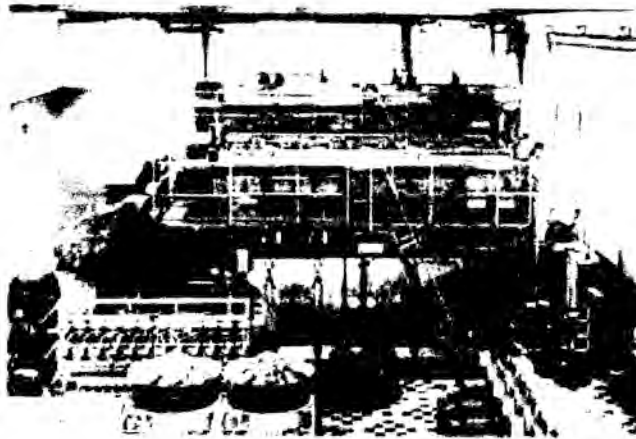

Fig. 2 The Faaborg Power Plant in 1925 had a diesel engine of 600 hp. It delivered heat to two schools and the manager's official residence. The power station was discontinued when electricity could be made cheaper on large power stations. However, a small power station was established in the city when the Faaborg district heating plant was built in 1995. Now, the generation of electricity has become almost a by-product of heat production. Photo: Faaborg Town History Archive.

In the 1930s, some systems that might be called district heating were installed. These block centres provided central heating to several of the homes in a settlement. If one strictly follows the definition of district heating in the official Dictionary of the Danish language — “heat delivered to multiple buildings from a heating plant” — it was district heating. If, on the other hand, the definition in Den Store Danske published by Gyldendal (the Danish counterpart to the British Encyclopaedia Britannica) — “distribution of heat through pipes to two or more properties with different owners” is used, these plants fell outside the definition. This combination of technical and legal criteria is the definition used by the district heating sector and partly in legislation (Fig. 3). In this article, however, I use the first definition, which is purely technological.

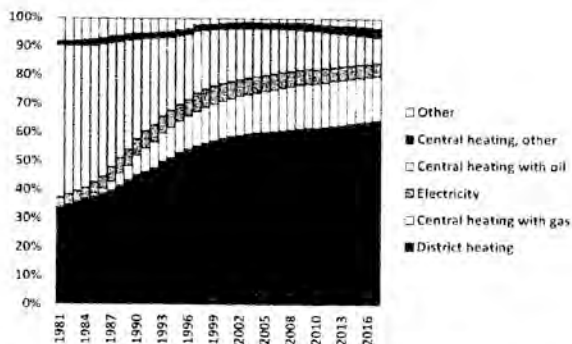

Fig. 3 District heating has slowly but surely reached far more than half of the country's households — by 2016, 64 percent. Around 85 percent of households receive piped energy when natural gas and electricity are counted. Source: Statistics Denmark.

The hidden system: How district heating came to town

The real breakthrough of district heating

While district heating was already a reality at the beginning of the twentieth century, the popular breakthroughs in the technology did not happen until later. After the establishment of plants to exploit surplus heat and the construction of block centres, interest in district heating waned, and from 1930 until the end of the 1940s only a few plants were created. One reason was, of course, that the war stopped societal development in many ways. The main reason, however, was that the easiest made plants had already been established.

We do not know the exact number of district heating plants that were in operation in Denmark during the first half of the century. At least a number of small district heating plants were shut down along with local power plants as the electricity sector centralized through the establishment of large power plants in the 1950s.

However, the number of new district heating plants exploded in the 16 years between 1950 and 1966. After the war, construction began slowly, with one new plant in 1947 and another in 1949. Then the number of new district heating plants rose to an average of five per year in the period from 1950 to 1958. Though that was a sharp rise, it was nothing compared to the explosion of district heating in the following years. In 1964, the biggest district heating year of all, 45 new plants came to be. In 1965, "only" half as many were established, and, in 1966, the number dropped to five new systems, and, in 1967, to only one. The big wave of development was over. In 16 years, more than 268 district heating plants had been launched.[3]

The reason for this unique period was that the post-war time was characterised by optimism everywhere that prosperity would return. The conditions did not normalise immediately after the end of the war. Everyone expected that product restrictions would be settled, but it took some time before reinforcing iron, radiators and oil could be purchased freely. The first district heating companies established just after the war, therefore, encountered major problems.

A popular movement

The new district heating plants were established with the boiler centre of primary importance. The plants were predominantly fired by the fuel of the new era: oil. Coal-fired plants were the exception, usually found in cities near brown coal fields. The spare heat from the power plants in the big cities was no longer the central source of heat: waste heat had become only supplemental. District heating, instead became the sole purpose of the plants, which often had no connection to a power station or municipal supply service.

With the use of oil, central heating could be for everyone. Growing car ownership had led to a residue from refineries, the so-called heavy fuel oil, which could not be burnt in the small furnaces of single-family houses. On the other hand, many households could agree on a large modern combustion plant with burners and preheaters that made burning of this fuel oil possible. It was no longer necessary to have a sweaty stoker shovel coal into the furnace. Automation meant the new oil burner only had to be inspected, and the oil was cheap and became still cheaper.

News of successful experiences with district heating in the first cities spread fast. Easy, cheap heat could be obtained by establishing a cooperative plant to serve owners of many houses. Enterprising engineers and blacksmiths travelled around the country and got busy designing installations and converting central heating systems in buildings. Homeowners met to discuss proposals, and often there was agreement that it should also be

attempted at their area. In many cities, local associations of craftsmen and citizens took the initiative on establishing plants. A proposal was discussed, a committee was set up, and after some preparatory work an independent district heating association was established. Parish and town councils coordinated the public interest in some cities, but there were also examples of municipalities, for various reasons, responding in the negative to requests that they get involved with district heating.

The district heating movement was a strong popular uprising, entirely in the spirit of the cooperative movement.

Start-up of a district heating system

Homeowners and local craftsmen could not establish a project alone — experts had to join the effort. One engineering company, Bruun & Sorensen, was, for many decades Denmark's leading — and almost exclusive — district heating consultant. When, later, there was an increase in the creation of smaller and simplified plants, a wide range of competitors emerged. Salespeople often marketed aggressively. They gradually moved far from their hometowns, where they contacted local people they believed might be able initiate local projects.

A district heating plant could only be established when a sufficient number of contracts with homeowners who wanted to be connected were signed. The contracts were based on the size of the houses. While, today, one only needs to get a computer printout from the public register of buildings, back then it was necessary to send people to homes with a measuring tape to determine how many cubic meters had to be heated.

There was an exciting period during which individual homeowners considered the offer. Would there be enough who wanted to join the system? At first, enrolment in nearly every city went very slowly. After some time, the entries reached the desired number — often a sufficient number was only achieved years later, after repeated campaigns. But, in general more joined after the plant had become a reality. Membership would continue to rise for years, to an extent few had imagined.

Not everyone was in favour of district heating. People with new oil burners naturally refrained from joining. More serious was organised resistance, usually business interests that were put at risk by the new initiative. For example, in 1963, local fuel dealers in a provincial town issued a flyer to the town's households in which they drew attention to the benefits of coal. Similarly, in 1965, the large gasworks Strandvejs Gasværket in the metropolitan area advertised the benefits of gas.[4]

In some places, resistance was successful. In the provincial town of Rudkøbing, for example, trade unions and traders got the city council to temporarily stop plans for a local district heating plant in 1963. The plant would have allowed a single man to operate a district heating plant in an area which hitherto had been handled by 32 people employed by the city's fuel companies.

Apart from the relatively few cases where a municipality established a district heating plant, most were established by self-governing institutions. A private, consumer-owned company would be headed by a general meeting-elected board. This popular commitment was great, but at in one area it was not enough: the funding. Funds needed to be borrowed, otherwise the connection fee would be too high. A loan required a guarantor, and most district heating companies received a guarantee from the municipality. After the Ministry of Internal Affairs had assessed the pledge of the project plan, the loan would be issued by the public fund *Kommunekredit*.

The hidden system: How district heating came to town

However, some municipalities considered the projects risky, and dared not make the guarantee. In addition, lending was limited in 1965, when the state wanted to slow down the overheated economy.

The pipes are laid — and become leaky

In a typical district heating plant, there was a small and usually not very flashy building to house a few overgrown domestic boilers of 65 m or 150 m heating surface, depending on the needs to be fulfilled. Even if these calculations kept for quite a few months — connections soon exceeded the planned capacity.

The city also had to be dug up and the necessary heating pipes laid down. The method at the time was to cast a concrete channel in which steel pipes were laid. In 1964, national TV showed a feature on a brand new pre-insulated district heating pipe, which a copper smith in Logstor had developed and patented. This plastic-wrapped tube later became a great success for the company Logstor Rør (now Logstor). Unfortunately, this was not the type of pipe that had been laid in most places, so in the course of just a few years, damage began to occur. Steel pipes could tear, which, as demonstrated by water meters at district heating plants, resulted in increased water loss. In the District Heating Association's membership magazine, cigars were offered to those who could devise a method to find the breaks. One of the proposals submitted was to use heat-seeking cats, but it is unknown if this suggestion earned cigars. (Fig. 4)

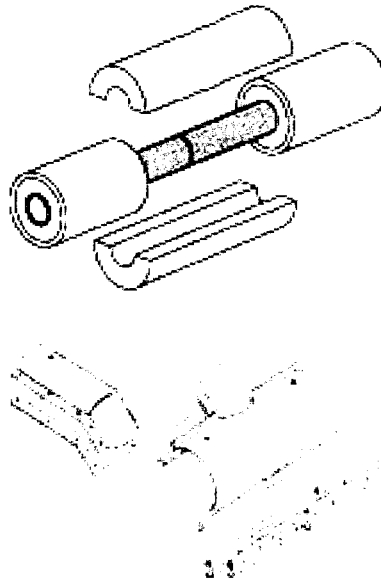

Fig. 4 Despite the fact that factories have developed a complete assembly set for district heating pipes, assembly has become a job for specialists. Illustration: Logstor.

Another problem was that pipes were often misplaced, a serious situation for many plants. One small district heating company had 30 to 40 pipe breaks in only one year. Several legal complaints were brought against the

guilty engineers.[5] One of those accused was the pipe production department at the company E. Rasmussen. That was one of the reasons why the company's name was changed when it was incorporated into the former trading company I.C. Møller (now a part of ABB). In this way, what became one of the world's leading companies had shaken off its sins of the past.

In many places it was necessary to replace the pipes, which was an expense not all district heating companies could afford. Thus, some companies chose to shut down the works instead of renovating. But most cooperatives chose to relocate the pipes, and after some economically hard years, progress was made with continued improvements. (Fig. 5)

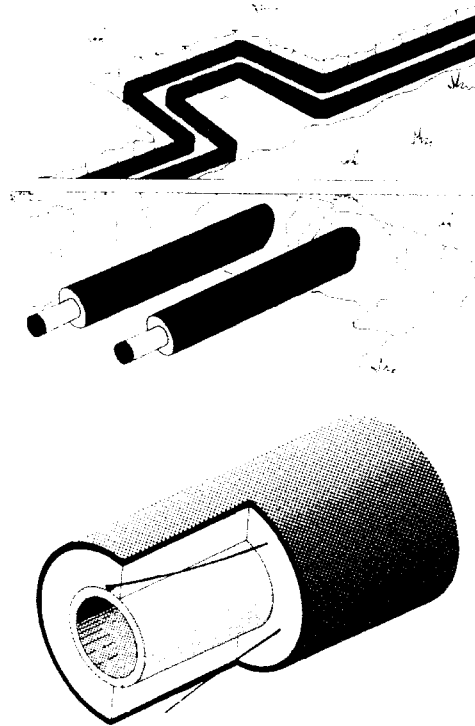

Fig. 5 A modern district heating pipe as supplied by the pipe plant. Around the inner steel pipe is insulation and there is a hard, protective layer. Inside the insulation are electrical wires used to locate possible damage.

Political management of the country's heating

On top of the technical problems with the pipes, new problems emerged. The price of oil rose dramatically during two energy crises, and, as a result, consumer heating prices also rose. This did not please consumers, who rarely had alternative heating options. And, if they did, the district heating plant had no interest in its customers using them. Several lawsuits led to consumers being forced to discontinue using their wood-burning stoves. In the

The hidden system: How district heating came to town

connection agreement with the district heating company, there was often a rule that it would supply all the heat customers used.

At the same time, the energy crises meant that the state and the public really began to interfere with the country's energy supply. It became official policy that the country should become independent of oil for heating. Across the country, oil-fired plants wholly or partially converted to coal in the early 1980s. That changed much, since heating with coal required more labour and a larger staff to care for the plants. Automatic firing stokers and computer-controlled coal-loading cranes were subsequently installed to reduce the cost of salaries.

However, the time of coal use was short. A few years later, political winds began to blow in the opposite direction. Now, the use of coal was considered a threat to the environment, and, in addition (and perhaps most importantly), natural gas from the Danish oil fields in the North Sea was available, and fixed district heating customers could help pay for the cost of installing a large natural gas network. However, natural gas could also be burned by individual consumers, and, to control development, the country was divided into separate areas — one for gas heating of houses and one for district heating — which the state strictly governed through legislation.

Since the energy crises of the 1970s, the government attempted, with both carrot and stick, to get the new policy implemented. The biggest stick was used by the Danish Energy Agency in 1991, when it wanted to convert to heat production based on combined heat and power plants (CHP) using natural gas and biofuels.[6] These new power plants would produce electricity and use the waste heat generated in the process for heating. There was a state reward for the production of electricity that was based on the number of produced kWh, (Fig. 6)

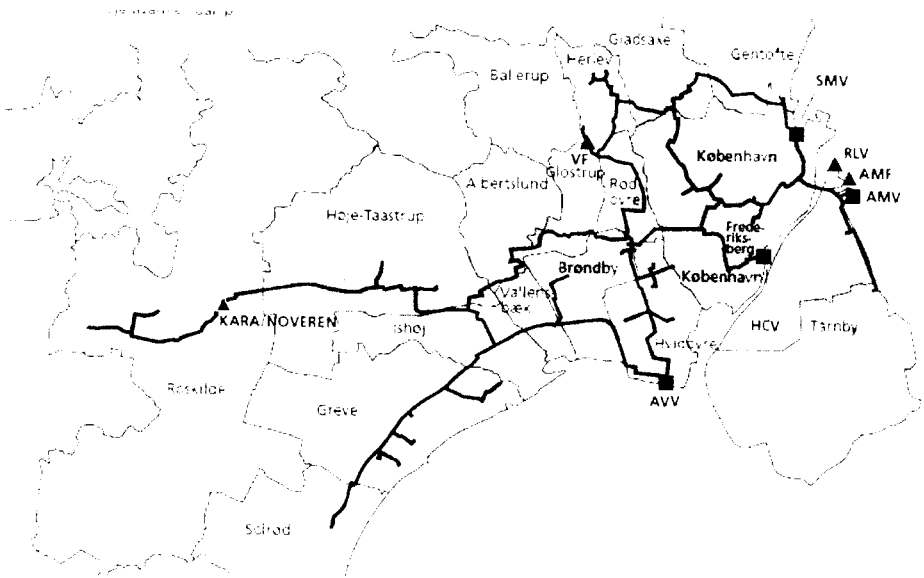

Fig. 6 Denmark's most widely used district heating system is found in Greater Copenhagen, the country's most densely populated area.

As mentioned above, exploitation of waste heat was not new. What was new was that even smaller communities could have the opportunity to establish district heating systems. If there were only a few hundred potential buyers in a fairly close settlement, then it would, at the time, pay to establish a decentralized CHP. Many new plants were set up as "greenfield" power plants in small towns. Denmark took the last steps needed to become one of the countries with the world's best-developed district heating (Fig. 7)

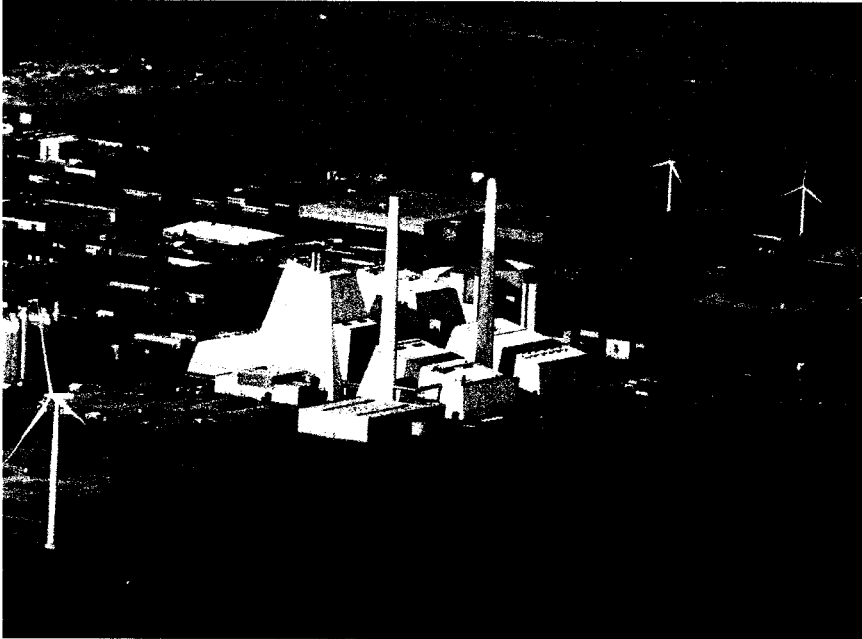

Fig. 7 Avedøreværket is the main supplier of district heating to 500,000 homes in the western suburbs of Copenhagen. The fuels are today only biofuels. The last expansion, of block 2, was completed in 2002. Photo: VEKS.

The new architecture

The new wave of buildings benefited from an architectural innovation: the great accumulation tank (Fig. 8). All the new plants needed a place to store heat when no electricity was produced. It was only part of the day when the gas engines were engaged. An efficient operation would let the engines make electricity when there was "peak load" or at least a "high load" on the electricity service. The "low load" periods, when electricity companies did not pay much for the flow, would be avoided. The tanks were so large that the heat could be stored for use during the nights and weekends. When Monday morning came, and industry again needed electricity, the water in the tank could be heated again.

The hidden system: How district heating came to town

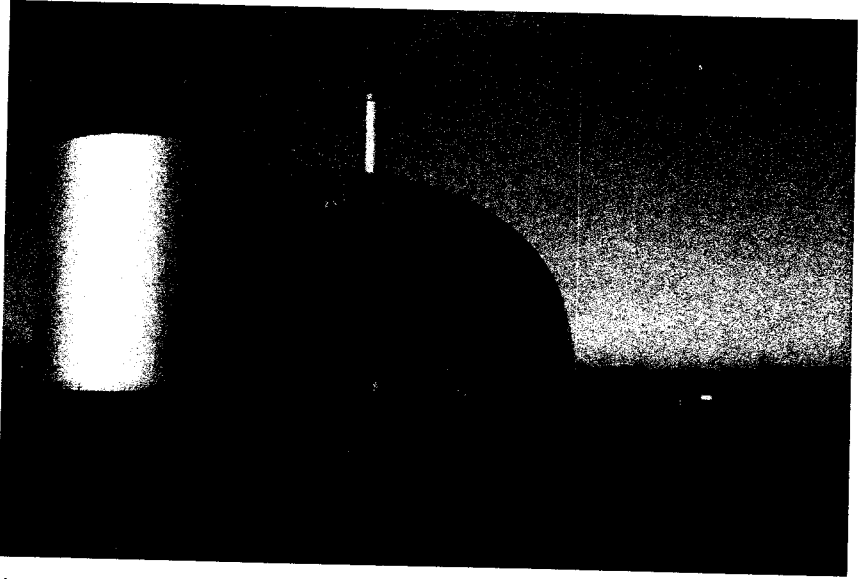

Fig. 8 Viborg Kraftvarmeværk, completed in 1996, is one of the 1990s' more architecturally beautiful facilities. It is built from a basic shape like two shells or hands that protect the machines. The shells integrate an accumulation tank for hot water. Photo: Energi Viborg.

The tanks, in their construction, are rather primitive. They are large insulated containers where the most technically sophisticated part is a so-called "vapor membrane" at the top of the tank, which prevents the air in the tank from circulating in the district heating system's pipelines. The tanks were installed in the hundreds across the country. They are so big that they far outweigh the adjacent buildings with machine houses and offices.

The expansion of facilities was very extensive in the 1990s. Where the buildings previously expanded gradually, in many cases large and complete plants were being built all at once. It enabled architects to design aesthetically beautiful and wholly owned plants. Where district heating plants were previously constructed anonymously and of the cheapest materials, the buildings were sometimes given an architectural expression — what first-generation electricity plants often had.

The hidden story

Strangely, nobody has systematised the historical knowledge of district heating in Denmark, the world's leading country in the field. Even the exact number of heating stations is unknown. A qualified estimate is that there are 1,600 stations, including everything from large buildings with waste incineration and/or central power generation, to small houses with a single, small gas engine, where the waste heat from electricity production is used for heating. In addition to the district heating plants themselves, many thousands of other construction sites should be included, such as pump and heat exchangers, valve wells, etc. With those buildings the district heating sector is not completely insignificant in the landscape image. One of the reasons for the lack of consideration of district heating may be that the system's main plant, the distribution plant, is hidden — buried well under the ground. It is

estimated that there are more than 30,000 km of district heating pipes.[7] That number should actually be multiplied by two, because there are both supply lines distributing heat and return lines containing cooled water.

Danish museums with rich collections document the cultural history of warming when technology was simple. Low-tech tools such as the stove, coal bowl and peat are found in most museums. But it seems that the museums' interest in the history of heat production disappeared as technology became more complicated. (Fig. 9)

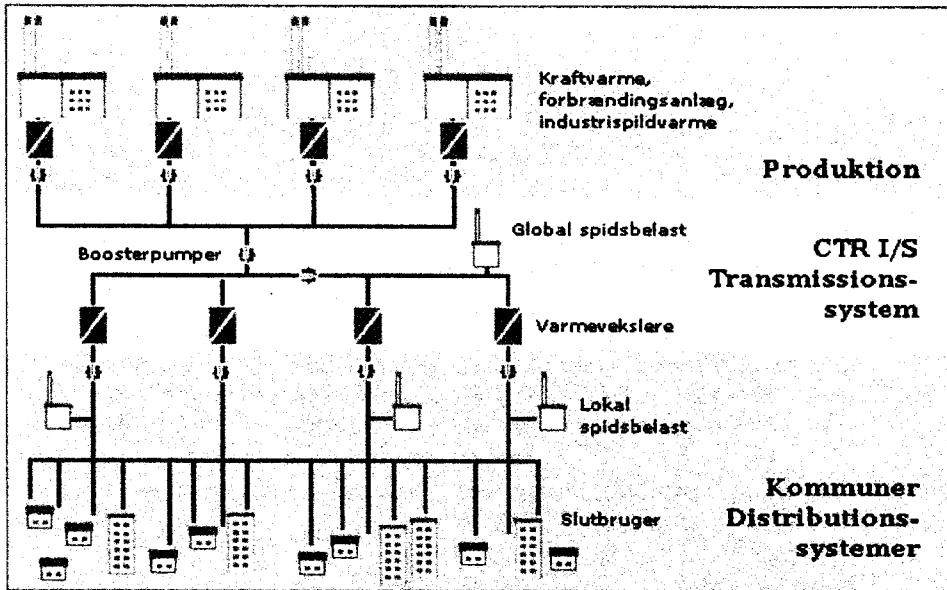

Fig. 9 The diagram shows the principle of the major utility company *Centralkommunernes Transmissionselskab I/S (CTR)* in the metropolitan area with a number of large heating systems. To provide enough heat during the coldest periods, there are also a number of additional peak load systems.

The physical changes in the home

One of the major recent changes in home heating was the introduction of central heating. Instead of heating with heat sources in each room, warmth was now obtained from just one single "oven" in the building. Previously, you could only place heat sources where there were chimneys, which is why many rooms were unheated. With central heating, radiators could easily be placed in all rooms. Additionally, by locating these on external walls, better heat distribution could be achieved. (Fig. 10)

The hidden system: How district heating came to town

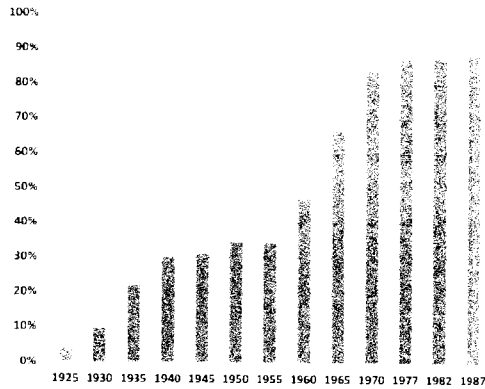

Fig. 10 Share of heating with radiators in Denmark. Until 1950 only apartments; later all kinds of homes. Source: Statistics Denmark.

The first central heating systems are lost in prehistory, but really began entering homes in the 1920s. However, it took a long time before a considerable portion homes were heated this way, and wasn't until after 1960 that only half of Danish homes had central heating. This meant significant changes in dwelling construction, as stoves disappeared from rooms. In apartment houses, individual fuel burners disappeared, to be replaced by central heat sources in basements. With central heating, it was also easy to deliver hot water from a central hot water tank.

District heating offered the same benefits, although many of the technical installations disappeared: the central kettle and fuel storage room were removed. Similarly, a chimney was no longer necessary, which, at the same time, offered more flexibility in placement of interior partition walls. A pipe from the distribution line under the sidewalk brought 60 to 70-degree Celsius water into the house, while another carried 40-degree cooled water back for reheating. (Fig. 11)

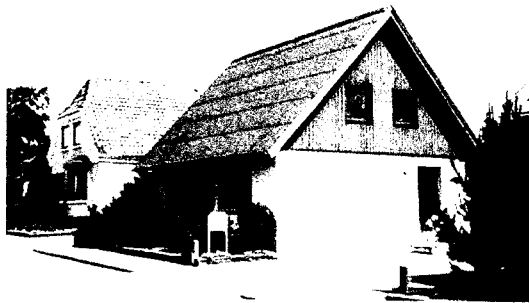

Fig. 11 The cityscape with houses without chimneys shows that there is district heating. There could, theoretically, also have been electric heating, but that expensive heating method was not very widespread due to its cost and requirement to connect to district heating.

Special installations for district heating were few. Shut-off valves for flow and return of water, as well as thermometers, manometers, heat exchangers and multiple valves were most often located in a small unit with all valves and control panels. There should be a measurement to determine the amount of water used using simple energy meter. The latest ones also give digital readings, so the annual manual read is avoided. Larger installations, particularly, will also install a pressure gauge that stops the supply of water in case of a larger leak. Hot water is now easily produced via a heat exchanger, so a larger hot water tank is not required. New installations do not require more than a small cabinet in a utility room.

Personal relationship to heating before and now

Mrs. Andersen sits snug indoors while a winter storm is howling outside. From the radiators, heat flows into her apartment. The thermostats ensure that the temperature is constant — it is "summer" all year. She does not think of the heat, except when she receives the heat bill. She feels the same way as most other Danes, a majority of whose homes are currently heated by district heating. Mrs. Andersen is an older lady, and she remembers, from her youth, how to handle firewood. Then, during the late summer, peat, wood or coke would be stored for winter consumption. In the winter months, she had to fire up the ovens with newspaper and wood shavings, and when the fire burned, a damper had to be turned so that the fire would get the right amount of air. Regularly, the ash should be emptied and taken away.

To keep warm in Mrs. Andersen's youth, everybody had to master a great deal of knowledge. Today, no ordinary citizen needs to have any specific knowledge of home heating. Winter heat has become a "distant" heat that "is just there". That does not mean that necessary knowledge has disappeared. On the contrary, it has never been so extensive, but it exists primarily outside the home. At the specialized heating centres there is a great deal of knowledge about firing for daily operation. This is where the year's warming is being planned and the daily work is done. This extensive understanding is only a small part of the total knowledge needed, though. When constructing the plant, a host of counsellors and engineers are available to draw and calculate how to assemble the many components that come from subcontractors. The production of these components is further based on a high level of knowledge from the subcontractors. In addition, fuel suppliers contribute important information regarding obtaining and supplying required fuel, whether it is coal, gas or oil. Behind each machine, each process or component requires technological knowledge based on research from universities and other research institutions.

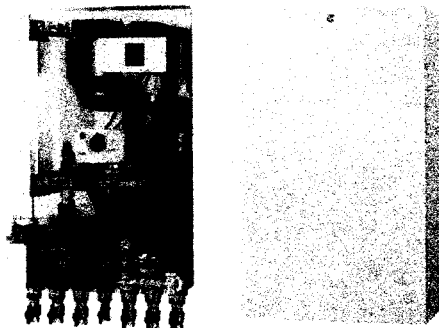

Fig. 12 Unit for a district heating installation in a small house. Illustration: Danfoss.

The hidden system: How district heating came to town

Conclusion

The combination of a political desire to control energy supply using less-polluting fuels, foreign policy concerns for suppliers and cheap prices for consumers has increased the use of district heating to 64 percent in Denmark.

The heat is produced in large plants of different types. Some heat comes from buildings intended exclusively to produce district heating. There are many different types depending on the size and type of fuel. Heat also comes as waste heat from the incineration of waste or the production of electricity. A distinctive type has been built since the 1990s to provide decentralized produced heat in parallel with the production of electricity. They are, in a way, a rebuilding of the small direct current power plants, which closed 60 years earlier. Their architectural expression is distinguished by their large hot water storage tanks.

Distribution of district heating inside buildings takes place in the same way as in central heating. There are major advantages for buildings that don't require chimneys, boiler rooms or fuel storage. Most of the special technical facilities are located in pipelines hidden under roads, and users shouldn't have to think much about their heat supply. The visible plant of district heating is usually far from housing, and the local installation can be stored in a closet. District heating has literally become a hidden system.

References

- [1] Burchardt, Jørgen: "Sommer hele året – signalement af den danske fjernvarme", in: *Teknisk Museums Årbog 2003-2004*, 2005, p. 9, and Burchardt, Jørgen: *Signalement af den danske fjernvarme*, Danmarks Tekniske Museum 2005 (unpublished report with a registration of the Danish district heating sector), p. 22.
- [2] Banham, Reyner: *The Architecture of the Well-Tempered Environment*, 2013, p. 46-47.
- [3] Burchardt, Jørgen: *Signalement af den danske fjernvarme*, Danmarks Tekniske Museum 2005 (unpublished report with a registration of the Danish district heating sector), p. 34-47.
- [4] *Ibid.*, p. 30-31.
- [5] *Ibid.*, p. 32-33.
- [6] Energistyrelsen: *Danmarks Energifortider. Hovedbegivenheder på energiområdet*, 2016, p. 31.
- [7] Information from the Danish District Heating Association.